



CAMPRI, spol. s r.o.



CENNÍK

PVC TLAKOVÉ SYSTÉMY
PVC HLADKÉ KANALIZAČNÉ SYSTÉMY
PVC KORUGOVANÉ SYSTÉMY

PLATNÝ OD 01. 02. 2020

Ceny sú uvedené v EUR bez DPH.

PVC tlakové

PVC-U POTRUBIE TLAKOVÉ					
POTRUBNÉ PVC-U SYSTÉMY PRE TLAKOVÝ ROZVOD VODY					
POTRUBIE PN 10, D 90 - D 450					
Rozmer	Balenie (m)	vonkajší priemer (mm)	hrúbka steny (mm)	počet ks v palete	EUR / kus
D 90	6	90	4,3	48	28,70
D 110	6	110	4,2	40	34,70
D 160	6	160	6,2	42	74,30
D 225	6	225	8,6	20	149,10
D 280	6	280	10,7	16	241,90
D 315	6	315	12,1	9	303,30
D 450	6	450	17,2		693,20

PVC-U POTRUBIE TLAKOVÉ					
POTRUBNÉ PVC-U SYSTÉMY PRE TLAKOVÝ ROZVOD VODY					
POTRUBIE PN 16, D 90 - D 315					
Rozmer	Balenie (m)	vonkajší priemer (mm)	hrúbka steny (mm)	počet ks v palete	EUR / kus
D 90	6	90	5,4	48	40,10
D 110	6	110	6,6	40	53,30
D 160	6	160	9,5	21	111,80
D 225	6	225	13,4	15	220,80
D 280	6	280	16,6	16	362,90
D 315	6	315	18,7	9	456,50

PVC-U PRESUVKA TLAKOVÁ (UNPL)		
POTRUBNÉ PVC-U SYSTÉMY PRE TLAKOVÝ ROZVOD VODY		
PRESUVKA PN 10, D 90 - D 315		
Rozmer		EUR / kus
D 90		9,03
D 110		13,14
D 160		22,44
D 225		33,23
D 315		59,35

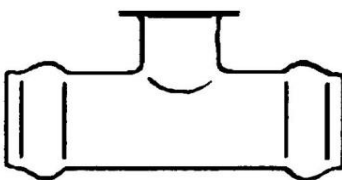
PVC-U TLAKOVÝ T- KUS S PRÍRUBOU (ANPL / ANPL-Z)		
POTRUBNÉ PVC-U SYSTÉMY PRE TLAKOVÝ ROZVOD VODY		
ANPL / ANPL-Z PN 10, D 90 - D 225		
Rozmer		EUR / kus
D 90/90		27,15
D 90/1 1/2"		22,80
D 110/80		33,53
D 110/100		34,09
D 110/2"		29,21
D 160/2"		45,21
D 160/90		53,71
D 160/110		60,28
D 160/160		67,85
D 225/160		97,19
D 225/225		103,63

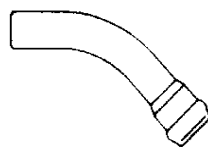
PVC-U TLAKOVÝ OBLÚK (KNPL) PN 10 a PN 16			
POTRUBNÉ PVC-U SYSTÉMY PRE TLAKOVÝ ROZVOD VODY			
OBLÚK PN 10, D 90			
Rozmer		hrúbka steny	EUR / kus
D 90/11 st.		3,5	7,90
D 90/22 st.		3,5	8,00
D 90/30 st.		3,5	8,50
D 90/45 st.		3,5	9,10
D 90/90 st.		3,5	13,50

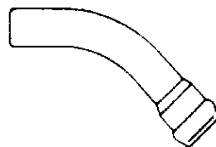
OBLÚK PN 10, D 110			
Rozmer		hrúbka steny	EUR / kus
D 110/11 st.		4,3	9,60
D 110/22 st.		4,3	10,80
D 110/30 st.		4,3	11,70
D 110/45 st.		4,3	13,00
D 110/90 st.		4,3	19,50

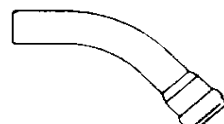
OBLÚK PN 10, D 160			
Rozmer		hrúbka steny	EUR / kus
D 160/11 st.		6,2	19,00
D 160/22 st.		6,2	21,00
D 160/30 st.		6,2	23,20
D 160/45 st.		6,2	27,00
D 160/90 st.		6,2	45,00

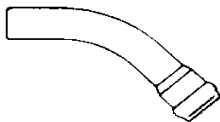
OBLÚK PN 10, D 225			
Rozmer		hrúbka steny	EUR / kus
D 225/11 st.		10,4	88,00
D 225/22 st.		10,4	82,00
D 225/30 st.		10,4	88,00
D 225/45 st.		10,4	99,00
D 225/90 st.		10,4	160,00

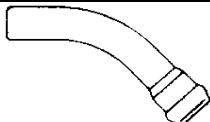
OBLÚK PN 10, D 280			
Rozmer		hrúbka steny	EUR / kus
D 280/11 st.		10,8	149,00
D 280/22 st.		10,8	165,00
D 280/30 st.		10,8	185,00
D 280/90 st.		10,8	295,00

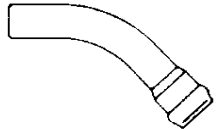
OBLÚK PN 10, D 315			
Rozmer		hrúbka steny	EUR / kus
D 315/11 st.		12,2	185,00
D 315/22 st.		12,2	225,00
D 315/30 st.		12,2	225,00
D 315/45 st.		12,2	288,00
D 315/90 st.		12,2	420,00

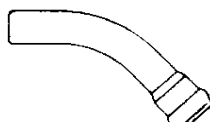
OBLÚK PN 16, D 160			
Rozmer		hrúbka steny	EUR / kus
D 160/11 st.		9,7	33,56
D 160/22 st.		9,7	35,82
D 160/30 st.		9,7	37,51
D 160/45 st.		9,7	41,09

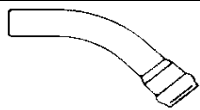
OBLÚK PN 16, D 315			
Rozmer		hrúbka steny	EUR / kus
D 315/11 st.		18,7	165,31
D 315/22 st.		18,7	165,31
D 315/30 st.		18,7	165,31

PVC-U TLAKOVÁ TVAROVKA ENPL (hrdlo + príruha)		
POTRUBNÉ PVC-U SYSTÉMY PRE TLAKOVÝ ROZVOD VODY		
PRÍRUBA - HRDLO PN 10, D 90 - 315		
Rozmer		EUR / kus
D 90		16,96
D 110		19,05
D 160		33,56
D 225		63,70
D 315		90,42

PVC-U TLAKOVÁ TVAROVKA FNPL (hladký koniec + príruha)		
POTRUBNÉ PVC-U SYSTÉMY PRE TLAKOVÝ ROZVOD VODY		
PRÍRUBA - HLADKÝ KONIEC PN 10, D 90 - 315		
Rozmer		EUR / kus
D 90		11,68
D 110		14,90
D 160		24,90
D 225		48,23
D 315		63,30

PVC hladké

PVC-U POTRUBIE HLADKÉ HRDLOVÉ					
POTRUBNÉ PVC-U SYSTÉMY PRE VONKAJŠIU KANALIZÁCIU					
POTRUBIE HLADKÉ HRDLOVÉ SN 4, D 110 - D 500					
Rozmer	Balenie (m)	vonkajší priemer (mm)	hrúbka steny (mm)	počet ks v palete	EUR / kus
D 110	0,5	110	3,2	60	3,79
D 110	1	110	3,2	60	4,94
D 110	2	110	3,2	60	7,47
D 110	3	110	3,2	60	9,84
D 110	5	110	3,2	60	15,10
D 125	0,5	125	3,2	60	3,79
D 125	1	125	3,2	60	5,65
D 125	2	125	3,2	60	8,15
D 125	3	125	3,2	60	11,30
D 125	5	125	3,2	60	17,20
D 140	1	140	3,6	53	7,50
D 140	2	140	3,6	53	11,10
D 140	3	140	3,6	53	16,20
D 140	5	140	3,6	53	24,73
D 160	0,5	160	4,0	33	4,97
D 160	1	160	4,0	33	7,94
D 160	2	160	4,0	33	11,80
D 160	3	160	4,0	33	17,70
D 160	5	160	4,0	33	27,40
D 200	0,5	200	4,9	23	7,51
D 200	1	200	4,9	23	11,30
D 200	2	200	4,9	23	18,50
D 200	3	200	4,9	23	26,10
D 200	5	200	4,9	23	42,20
D 250	1	250	6,2	16	21,80
D 250	2	250	6,2	16	35,70
D 250	3	250	6,2	16	55,10
D 250	5	250	6,2	16	79,80
D 315	1	315	7,7	9	36,30
D 315	2	315	7,7	9	55,00
D 315	3	315	7,7	9	77,00
D 315	5	315	7,7	9	113,00
D 400	1	400	9,8	6	58,00
D 400	2	400	9,8	6	91,00
D 400	3	400	9,8	6	126,00
D 400	5	400	9,8	6	185,00
D 500	1	500	12,2	4	98,50
D 500	2	500	12,2	4	171,10
D 500	3	500	12,2	4	243,40
D 500	5	500	12,2	4	338,30

PVC-U POTRUBIE HLADKÉ HRDLOVÉ					
POTRUBNÉ PVC-U SYSTÉMY PRE VONKAJŠIU KANALIZÁCIU					
POTRUBIE HLADKÉ HRDLOVÉ SN 8, D 110 - D 400					
Rozmer	Balenie (m)	vonkajší priemer (mm)	hrúbka steny (mm)	počet ks v palete	EUR / kus
D 110	1	110	3,2	54	6,20
D 110	2	110	3,2	54	11,80
D 110	3	110	3,2	54	17,40
D 110	5	110	3,2	54	28,60
D 110	6	110	3,2	54	34,00
D 125	1	125	3,7	48	7,70
D 125	2	125	3,7	48	14,60
D 125	3	125	3,7	48	21,10
D 125	5	125	3,7	48	34,70
D 125	6	125	3,7	48	41,00
D 160	1	160	4,7	42	7,60
D 160	2	160	4,7	42	13,90
D 160	3	160	4,7	42	20,30
D 160	5	160	4,7	42	29,80
D 160	6	160	4,7	42	38,60
D 200	1	200	6,4	36	11,90
D 200	2	200	6,4	36	21,80
D 200	3	200	6,4	36	31,20
D 200	5	200	6,4	36	47,00
D 200	6	200	6,4	36	61,00
D 250	1	250	7,3	16	21,00
D 250	2	250	7,3	16	36,00
D 250	5	250	7,3	16	78,00
D 315	1	315	9,2	9	31,00
D 315	2	315	9,2	9	56,00
D 315	5	315	9,2	9	119,00
D 400	1	400	11,7	6	51,00
D 400	2	400	11,7	6	88,00
D 400	5	400	11,7	6	195,00

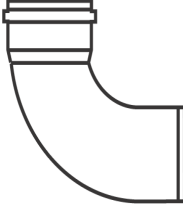
PVC-U KOLENO KANALIZAČNÉ KGB 15°		
POTRUBNÉ PVC-U SYSTÉMY PRE VONKAJŠIU KANALIZÁCIU		
KGB 15st. D 110 - D 500		
Rozmer		EUR / kus
D 110/15		1,12
D 125/15		1,59
D 160/15		2,82
D 200/15		5,48
D 250/15		19,60
D 315/15		32,90
D 400/15		68,40
D 500/15		150,30

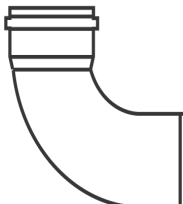
PVC-U KOLENO KANALIZAČNÉ KGB 30°		
POTRUBNÉ PVC-U SYSTÉMY PRE VONKAJŠIU KANALIZÁCIU		
KGB 30st. D 110 - D 500		
Rozmer		EUR / kus
D 110/30		1,16
D 125/30		1,63
D 140/30		3,73
D 160/30		2,79
D 200/30		5,64
D 250/30		19,60
D 315/30		33,90
D 400/30		76,30
D 500/30	185,90	

PVC-U KOLENO KANALIZAČNÉ KGB 45°		
POTRUBNÉ PVC-U SYSTÉMY PRE VONKAJŠIU KANALIZÁCIU		
KGB 45st. D 110 - D 500		
Rozmer		EUR / kus
D 110/45		1,19
D 125/45		1,53
D 140/45		4,00
D 160/45		2,95
D 200/45		5,71
D 250/45		16,90
D 315/45		33,90
D 400/45		79,70
D 500/45	249,00	

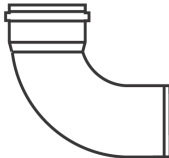
PVC-U KOLENO KANALIZAČNÉ KGB 60°		
POTRUBNÉ PVC-U SYSTÉMY PRE VONKAJŠIU KANALIZÁCIU		
KGB 60st. D 110 - D 200		
Rozmer		EUR / kus
D 110/60		1,49
D 125/60		2,12
D 140/60		4,08
D 160/60		3,82
D 200/60		6,31

PVC-U KOLENO KANALIZAČNÉ KGB 87°		
POTRUBNÉ PVC-U SYSTÉMY PRE VONKAJŠIU KANALIZÁCIU		
KGB 87st. D 110 - D 500		
Rozmer		EUR / kus
D 110/87		1,46
D 125/87		2,36
D 140/87		4,48
D 160/87		3,49
D 200/87		6,97
D 250/87		23,60
D 315/87		36,20
D 400/87		125,50
D 500/87		315,30

PVC-U PÄTKOVÉ KOLENO KANALIZAČNÉ		
POTRUBNÉ PVC-U SYSTÉMY PRE VONKAJŠIU KANALIZÁCIU		
D 110 - D 200		
Rozmer		EUR / kus
D 110/110		9,79
D 110/125		11,72
D 110/140		5,92
D 125/125		10,75
D 125/160		13,01
D 140/140		12,65
D 140/160		8,90
D 160/160		13,28
D 160/200		11,92
D 200/200		16,70

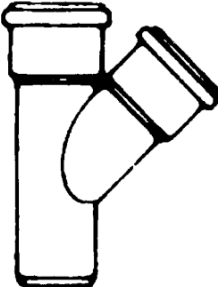
PVC-U ODBOČKA KANALIZAČNÁ KGEA 45°		
POTRUBNÉ PVC-U SYSTÉMY PRE VONKAJŠIU KANALIZÁCIU		
KGEA 45st. D 110 - D 500		
Rozmer		EUR / kus
D 110/110		2,72
D 125/110		3,25
D 125/125		3,65
D 140/125		4,49
D 160/110		4,61
D 160/125		5,05
D 160/160		6,54
D 200/110		9,16
D 200/125		10,90
D 200/160		14,40
D 200/200		13,30
D 250/110		20,10
D 250/125		25,50
D 250/160		39,80
D 250/200		31,20
D 250/250		36,50
D 315/110		37,50
D 315/125		37,50
D 315/160		40,80
D 315/200		46,80
D 315/250		94,60
D 315/315		82,00
D 400/160		121,20
D 400/200		121,40
D 400/250		157,70
D 400/300		184,80
D 400/400		285,50
D 500/160		236,40
D 500/200		262,10
D 500/250		303,80
D 500/315	348,50	
D 500/400	363,50	
D 500/500	390,50	

PVC-U ODBOČKA KANALIZAČNÁ KGEA 60°		
POTRUBNÉ PVC-U SYSTÉMY PRE VONKAJŠIU KANALIZÁCIU		
KGEA 60st. D 110 - D 160		
Rozmer		EUR / kus
D 140/110		4,84
D 140/140		6,00
D 160/140		7,00

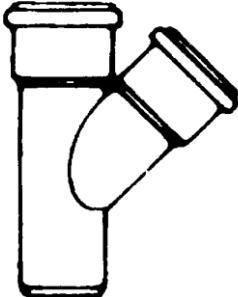
PVC-U ODBOČKA KANALIZAČNÁ KGEA 87°		
POTRUBNÉ PVC-U SYSTÉMY PRE VONKAJŠIU KANALIZÁCIU		
KGEA 87st. D 110 - D 500		
Rozmer		EUR / kus
D 110/110		3,22
D 125/110		3,62
D 125/125		3,85
D 160/110		5,15
D 160/125		5,91
D 160/160		7,27
D 200/110		10,30
D 200/125		11,60
D 200/160		12,60
D 200/200		13,40
D 250/160		32,60
D 250/200		31,60
D 250/250		29,50
D 315/160		72,60
D 315/200		87,60
D 315/250		29,50
D 315/315		104,20
D 400/160		127,80
D 400/200		113,10
D 400/300		156,70
D 400/400		243,00
D 500/160		236,40
D 500/200		265,30
D 500/250		306,50
D 500/300		333,90
D 500/400	404,30	
D 500/500	404,20	

PVC-U ODBOČKA KANALIZAČNÁ NALEPOVACIA 45°		
POTRUBNÉ PVC-U SYSTÉMY PRE VONKAJŠIU KANALIZÁCIU		
45st. D 150 - D 400		
Rozmer		EUR / kus
D 150/125		5,84
D 200/125		8,20
D 200/150		11,00
D 250/125		12,30
D 250/150		16,10
D 315/125		18,50
D 315/150		24,20
D 400/125		22,50
D 400/150		26,30

PVC-U SPÄTNÁ KLAPKA (KGKLAP)		
POTRUBNÉ PVC-U SYSTÉMY PRE VONKAJŠIU KANALIZÁCIU		
KGKLAP D 110 - D 400		
Rozmer		EUR / kus
D 110		73,20
D 125		75,20
D 160		93,90
D 200		116,70
D 250		179,20
D 315		350,30
D 400		980,00

PVC-U PRECHOD ŠACHTOVÝ KANALIZAČNÝ (KGAM) jednoduchý		
POTRUBNÉ PVC-U SYSTÉMY PRE VONKAJŠIU KANALIZÁCIU		
KGAM D 110 - D 200		
Rozmer		EUR / kus
D 110		1,53
D 125		2,16
D 160		3,29
D 200		6,64

PVC-U PRECHOD ŠACHTOVÝ KANALIZAČNÝ (KGAMS) pieskovaný		
POTRUBNÉ PVC-U SYSTÉMY PRE VONKAJŠIU KANALIZÁCIU		
KGAMS D 110 - D 500		
Rozmer		EUR / kus
D 110		4,08
D 125		4,78
D 160		7,63
D 200		8,90
D 250		21,30
D 315		32,50
D 400		48,20
D 500		209,10

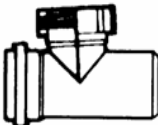
PVC-U ČISTIACI KUS (KGRE)		
POTRUBNÉ PVC-U SYSTÉMY PRE VONKAJŠIU KANALIZÁCIU		
KGRE D 110 - D 315		
Rozmer		EUR / kus
D 110		7,63
D 125		10,50
D 160		16,40
D 200		27,10
D 250		99,90
D 315		154,40

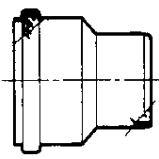
PVC-U PRECHOD - KAMENINA ► PVC (KGUS)		
POTRUBNÉ PVC-U SYSTÉMY PRE VONKAJŠIU KANALIZÁCIU		
KGUS D 110 - D 300		
Rozmer		EUR / kus
D 110		5,08
D 125		8,80
D 160		12,70
D 200		23,00
D 300		113,70

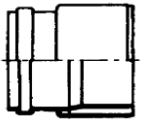
PVC-U PRECHOD - PVC ► KAMENINA (KGUSM)		
POTRUBNÉ PVC-U SYSTÉMY PRE VONKAJŠIU KANALIZÁCIU		
KGUSM D 110 - D 200		
Rozmer		EUR / kus
D 110		2,92
D 125		3,68
D 160		4,15
D 200		14,40

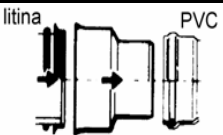
PVC-U PRECHOD - LIATINA ► PVC (KGUG)		
POTRUBNÉ PVC-U SYSTÉMY PRE VONKAJŠIU KANALIZÁCIU		
KGUSM D 110 - D 200		
Rozmer		EUR / kus
D 110		2,32
D 125		4,38
D 160		5,81
D 200		15,80

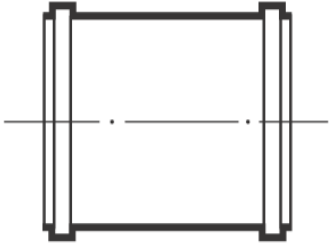
PVC-U PRESUVKA KANALIZAČNÁ HLADKÁ (KGU)		
POTRUBNÉ PVC-U SYSTÉMY PRE VONKAJŠIU KANALIZÁCIU		
KGU D 110 - D 500		
Rozmer		EUR / kus
D 110		1,33
D 125		1,86
D 160		2,99
D 200		5,61
D 250		14,60
D 315		24,90
D 400		50,50
D 500		102,90

IN SITU VRTÁK NA PVC RÚRY		
POTRUBNÉ PVC-U SYSTÉMY PRE VONKAJŠIU KANALIZÁCIU		
D 160 - D 200		
Rozmer		EUR / kus
D 160		495,00
D 200		495,00

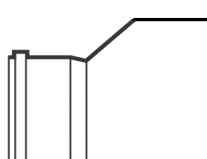
PVC-U REDUKCIA KANALIZAČNÁ HLADKÁ (KGR)		
POTRUBNÉ PVC-U SYSTÉMY PRE VONKAJŠIU KANALIZÁCIU		
KGR D 110 - D 500		
Rozmer		EUR / kus
D 110/125		1,23
D 110/140		2,99
D 110/160		1,86
D 125/140		2,79
D 125/160		1,99
D 140/160		3,73
D 125/200		4,28
D 160/200		3,78
D 250/160		15,60
D 200/250		19,60
D 315/200		23,20
D 315/250		25,60
D 400/315		59,70
D 500/400		149,40

PVC-U ZÁTKA/UPCHÁVKA KANALIZAČNÁ (KGM)			
POTRUBNÉ PVC-U SYSTÉMY PRE VONKAJŠIU KANALIZÁCIU			
KGM D 110 - D 1000			
Rozmer		EUR / kus	
D 110		0,60	
D 125		0,83	
D 160		1,03	
D 200		2,39	
D 250		12,40	
D 315		21,60	
D 400		31,50	
D 500		142,70	
D 250		korug. do hrdla	40,40
D 315		korug. do hrdla	43,70
D 400	korug. do hrdla	51,15	
D 600	korug. do hrdla	140,11	
D 315-K	veko na hl. koniec	14,90	
D 400-K	veko na hl. koniec	24,50	
D 600-K	vrchnák na hl. koniec	79,90	
D 800-K	vrchnák na hl. koniec	190,10	
D 1000-K	vrchnák na hl. koniec	266,30	



Hlohovecká 13, 951 41 Lužianky
www.campri.sk, e-mail: campri@campri.sk
tel.:(0)37 692 16 00-07, fax:(0)37 692 16 14-15

IN SITU SPOJKY		
POTRUBNÉ PVC-U SYSTÉMY PRE VONKAJŠIU KANALIZÁCIU KORUGOVANÚ		
D 160 - D 200		
Rozmer		EUR / kus
D 160		18,00
D 200		30,00

PVC korugované

PVC-U POTRUBIE KORUGOVANÉ					
POTRUBNÉ PVC-U SYSTÉMY PRE VONKAJŠIU KANALIZÁCIU					
POTRUBIE KORUGOVANÉ HRDLOVÉ SN 4, D 300					
Rozmer	Balenie (m)	vonkajší priemer (mm)	vnútorný priemer (mm)	počet ks v palete	EUR / kus
D 300	3	330,7	303,5	9	66,00
D 300	5	330,7	303,5	9	103,40
D 300	6	330,7	303,5	9	122,90

PVC-U POTRUBIE KORUGOVANÉ					
POTRUBNÉ PVC-U SYSTÉMY PRE VONKAJŠIU KANALIZÁCIU					
POTRUBIE KORUGOVANÉ HRDLOVÉ SN 8, D 200 - D 1000					
Rozmer	Balenie (m)	vonkajší priemer (mm)	vnútorný priemer (mm)	počet ks v palete	EUR / kus
D 200	5			20/25	68,00
D 250	3	268,9	246,5	16	59,00
D 250	5	268,9	246,5	16	88,80
D 250	6	268,9	246,5	16	106,10
D 300	3	330,7	303,5	9	82,70
D 300	5	330,7	303,5	9	118,70
D 300	6	330,7	303,5	9	139,20
D 400	3	427,0	392,0	6	135,56
D 400	5	427,0	392,0	6	217,79
D 400	6	427,0	392,0	6	259,14
D 500	6	542,5	494,8	4	465,20
D 600	6,1				818,26
D 800	6,3				1434,08
D 1000	6				1992,80

PVC-U POTRUBIE KORUGOVANÉ					
POTRUBNÉ PVC-U SYSTÉMY PRE VONKAJŠIU KANALIZÁCIU					
POTRUBIE KORUGOVANÉ HRDLOVÉ SN 10, D 250 - D 500					
Rozmer	Balenie (m)	vonkajší priemer (mm)	vnútorný priemer (mm)	počet ks v palete	EUR / kus
D 250	3	268,9	246,5	16	74,00
D 250	5	268,9	246,5	16	111,00
D 250	6	268,9	246,5	16	133,00
D 300	3	330,7	303,5	9	104,00
D 300	5	330,7	303,5	9	148,00
D 300	6	330,7	303,5	9	174,00
D 400	3	427,0	392,0	6	163,00
D 400	5	427,0	392,0	6	258,00
D 400	6	427,0	392,0	6	306,00
D 500	3	542,5	494,8	4	321,00
D 500	5	542,5	494,8	4	502,00
D 500	6	542,5	494,8	4	582,00

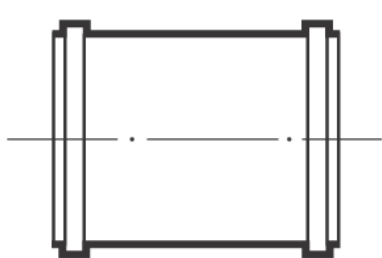
PVC-U PRESUVKA KDU KORUGOVANÁ		
POTRUBNÉ PVC-U SYSTÉMY PRE VONKAJŠIU KANALIZÁCIU		
KDU D 200 - D 1000		
Rozmer		EUR / kus
D 200		5,81
D 250		18,80
D 300		23,90
D 400		32,30
D 500		105,20
D 600		92,21
D 800		233,95
D 1000		397,60

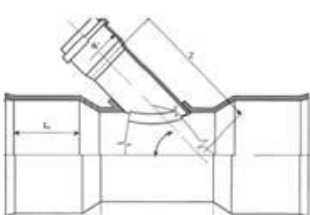
PVC-U ODBOČKA KDEA 45° KORUGO - HLADKÁ		
POTRUBNÉ PVC-U SYSTÉMY PRE VONKAJŠIU KANALIZÁCIU		
KDEA 45st. D 200 - D 1000		
Rozmer		EUR / kus
D 200/200		11,95
D 250/160		51,80
D 250/200		61,10
D 250/250		71,00
D 300/160		45,30
D 300/200		47,90
D 300/250		105,00
D 300/315		125,00
D 400/160		57,69
D 400/200		63,47
D 500/160		213,50
D 500/200		226,50
D 600/160		152,33
D 600/200		165,04
D 600/300		246,63
D 800/160		288,36
D 800/200		297,38
D 1000/160		471,49
D 1000/200		475,10

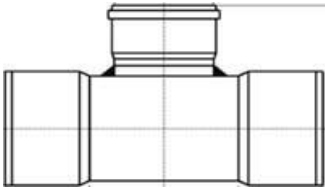
PVC-U ODBOČKA KDEA 90° KORUGO - HLADKÁ		
POTRUBNÉ PVC-U SYSTÉMY PRE VONKAJŠIU KANALIZÁCIU		
KDEA 45st. D 250 - D 500		
Rozmer		EUR / kus
D 250/160		65,90
D 250/200		59,30
D 250/250		76,50
D 300/160		73,00
D 300/200		52,40
D 300/250		105,00
D 300/315		120,50
D 400/160		141,50
D 400/200		146,40
D 500/160		226,50
D 500/200		252,00
D 500/250		264,00
D 500/315		272,00
D 500/400		342,00

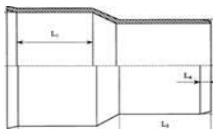
PVC-U PRECHOD Z KORUGO DO HLADKÉHO KG HRDLA		
POTRUBNÉ PVC-U SYSTÉMY PRE VONKAJŠIU KANALIZÁCIU		
KDPS D 250 - D 500		
Rozmer		EUR / kus
D 250/250		21,20
D 300/315		31,00
D 400/400		48,50
D 500/500		98,50

PVC-U KOLENO KANÁLOVÉ KORUGOVANÉ - SEGMENTOVÉ		
POTRUBNÉ PVC-U SYSTÉMY PRE VONKAJŠIU KANALIZÁCIU		
Rozmer		EUR / kus
D 200/15st.		4,91
D 300/11st.		77,31
D 300/22st.		77,31
D 300/30st.		77,31
D 300/45st.		77,31
D 300/60st.		77,31
D 300/90st.		86,14



Hlohovecká 13, 951 41 Lužianky
www.campri.sk, e-mail: campri@campri.sk
tel.:(0)37 692 16 00-07, fax:(0)37 692 16 14-15

PVC-U PRECHODKA (VLOŽKA) ŠACHT. KANÁL. KORUGOVANÁ		
POTRUBNÉ PVC-U SYSTÉMY PRE VONKAJŠIU KANALIZÁCIU		
Rozmer		EUR / kus
D 300		16,80
D 400		21,41
D 500		100,20
D 600		67,08
D 800		155,91
D 1000		254,60



CAMPRI, spol. s r.o.
Hlohovecká 13
951 41 Lužianky

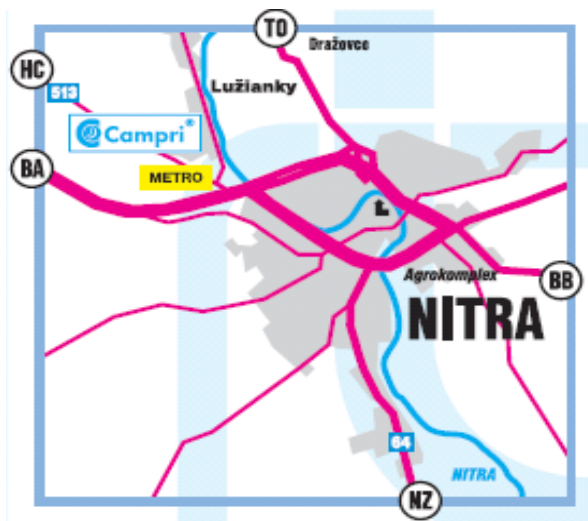

Obchod:

Tel.: 037/692 16 00 - 07

0903 481 716
0903 703 359
0903 806 813
0903 575 747
0911 895 917
0911 248 485

Výroba:

Tel./Fax: 037/692 16 22

e-mail: campri@campri.sk
www.campri.sk